

OPERATOR'S MANUAL

ENGLISH

PAG. 2

Manufacturer of this appliance is

S.P.M. Drink Systems S.p.A. – Via Panaro 2/b 41057 Spilamberto (MO)

All reproduction rights of this manual are reserved to it, even partial reproduction is prohibited.

The descriptions and illustrations refer to the specific machine/plant in question. The manufacturer reserves the right to make any modifications he deems appropriate to series production at any time.

This manual:

- it is an integral part of the supply and must be read carefully in order to use it correctly, in compliance with the essential safety requirements;

- it is drawn up according to the provisions of the Machinery Directive 2006/42/EC and contains the technical information necessary to correctly carry out all the procedures in safe conditions;

- it must be stored with care (protected in a transparent and watertight casing to prevent deterioration) and must accompany the machine throughout its life, including any change of ownership. In the event of loss or deterioration, a copy can be obtained by requesting the manufacturer, reporting the data on the identification plate

The manufacturer declines all responsibility for improper use of the machine/plant and/or for damage caused as a result of operations not covered in this manual.

INDEX

1. SAFE OPERATION INSTRUCTIONS	4
Cleaning and daily sanitizing procedures	5
Sanitizing	8
Seals control and replacement	8
2. TECHNICAL SPECIFICATIONS	9
3. POSITIONING	9
4. CONNECTION TO THE POWER SUPPLY MAINS.....	10
5. START-UP PROCEDURES AND OPERATING INSTRUCTIONS	11
Summer storage	13
Product storage.....	13
6. DISCLAIMER	13
7. WIRING DIAGRAM.....	14

1. SAFE OPERATION INSTRUCTIONS

This installation and operation manual is an integral part of the equipment and must be kept for future consultation.

Unless otherwise stated, this manual is addressed to operators (staff members who uses the equipment on a daily basis) and to servicemen (staff members qualified to carry out the installation and/or maintenance). **T**he parts of the manual addressed only to servicemen are pointed out accordingly. Please read carefully the warnings listed here below before installation and start-up of the equipment.

This equipment has been designed to produce hot chocolate and similar products, do not use for melt frozen product and in case the product is frozen, do not operate the appliance

Upon receipt of the equipment, make sure that its part number matches the one specified in the order, which can be found on all the delivery documents.

This equipment is exclusively destined to the purpose for which it was designed.

The manufacturer cannot be held responsible for any damage due to improper use.

This appliance can be used by children aged from 8 years and above and persons with reduced physical, sensory or mental capabilities or lack of experience and knowledge if they have been given supervision or instruction concerning use of the appliance in a safe way and understand the hazards involved. **C**hildren shall not play with the appliance. **C**leaning and user maintenance shall not be made by children without supervision.

This equipment is not suitable for outdoor use. This machine is not suitable for installation in locations where water jets are used and it must not be cleaned by a water jet.

The appliance is only to be installed in locations where its use and maintenance is restricted to trained personnel.

Do not store explosive substances such as aerosol cans with a flammable propellant in this appliance.

This appliance is intended to be used in household and similar applications such as

- **S**taff kitchen areas in shops, offices and other working environments;
- **f**arm houses and by clients in hotels, motels and other residential type environments;
- **b**ed and breakfast type environments;
- **C**atering and similar non-retail applications.

The installation and subsequent servicing operations must be carried out by skilled members who have been trained to use the device and in compliance with the regulations in force.

The machine has to be placed on a sturdy, horizontal surface making sure it is well ventilated by leaving a gap of 20 cm around it and do not install it near heat sources (fig.1); **w**e recommend you to maintain a room temperature between 24 and 30°C (between 75°F and 86°F).

For a safe and correct installation, it is essential to provide a suitable socket controlled by a thermal cut-out switch whose contacts are at least 3 mm apart, in accordance with the current national safety regulations.

If the power cable is damaged, it must be replaced by the manufacturer, its after sale service or by qualified personnel, to prevent any possible risk.

The continuous, equivalent, weighted level of acoustic pressure is below 70 dB.

Cleaning and daily sanitizing procedures

In order to maintain the unit in like-new operating condition and to respect current regulations, it's absolutely necessary to frequently and carefully perform the cleaning and sanitizing operations as described below.

In case of prolonged shutdown (winter storage), the machine must be disassembled, washed and sanitized according to the instructions in this manual before start-up to ensure the best possible cleanliness.

⚠ Caution ⚠

Electric shock hazard. Do not splash water on switches or allow water to flow onto electrical components inside the machine.

⚠ Caution ⚠

To prevent bacteria growth, use only sanitizers approved for plastic and rubber objects, failure to do so could create a health hazard.

Note: it is responsibility of the operator to be aware of and conform to the requirements of current local, state and federal laws concerning the frequency of cleaning and conservation of products used.

The cleaning instructions explained in this section are essential procedures to remove bacteria and maintain a sanitarly clean machine.

We recommend to perform the cleaning and sanitizing procedures every day and anyway according to the local laws.

The machine and the mix manufacturers decline all responsibility to damage that directly or indirectly derives from people, animals, as consequence of failure to comply with all cleaning and sanitation instructions indicated in this manual.

⚠ Attention ⚠

Burn risk



Never touch the plate with hands when the container is not positioned in its place (see picture 14)

⚠ Caution ⚠

To avoid electrical shock or contact with moving parts, before proceeding with the disassembling operations, make sure all switches are in "OFF" position and that the main power supply is disconnected.

- Turn off the machine with switch (B) (see fig. 11) and unplug it at the mains.

- Provide yourself with a sanitizer suitable for plastic, rubber and stainless steel objects

(Sodium hypochlorite 2%), for the US market bring the approved KAY-5® Sanitizer/Cleaner with a 100ppm dilution (1 Oz packet of KAY-5® + 2 ½ gallons of water) (the sanitizing product shall comply with 40 CFR §180.940).

IMPORTANT

Carefully follow the mix producer prescriptions in terms of time and modes of conservation.

- Wash and sanitize your hands and forearms.

- Remove the lid.

- Using two container holders, in order to avoid burns hands, grasp container (A) and lift it

upwards. The container and mixer (E) will be automatically released from their seat (see fig. 1).

- Cool the container (A) (by dipping it in cold water, for example).

- Simultaneously press the two securing tabs and lift the tap to extract it from its seat (see fig.2).

- Disassemble the tap by keeping the body pressed down and slipping the lever from its seat (fig.3).

⚠ Caution ⚠

To prevent bacteria growth, remove all

O-rings when cleaning.

Failure to do so could create a health hazard.

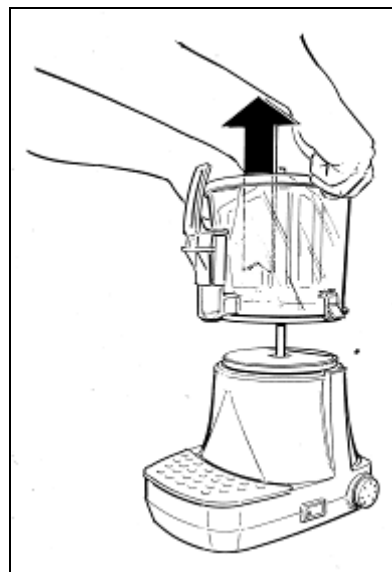

Fig. 1

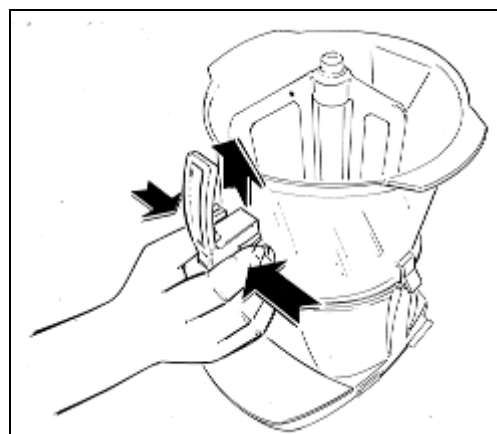

Fig. 2

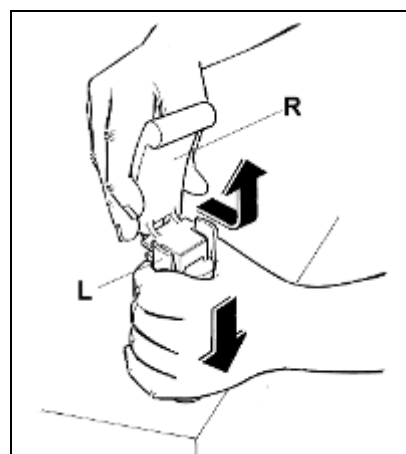

Fig. 3

- **P**lace the container (A) on a flat surface (fig. 4).
- 4). **G**rasp the central shaft with one hand and pull lever F (fig 7) outwards with the other in order to disassemble the bowl into the stainless steel base and the transparent cylinder.
- **T**o remove the drip tray (P) lift up it and pull it in the direction of the arrows as shown in fig. 6.
- **T**horoughly wash all the removed components with hot water and dishwashing, but do not use abrasive detergents or powders that can damage the bowl.

IMPORTANT

Do not use too aggressive sanitizers or detergents, these kind of products could damage the bowl and the other components.

CAUTION

Never perform these washing operation with a dish washing machine; failure to do so could seriously damage the unit's parts.

- **R**inse well and then place all the components in the sanitizer solution; for proper sanitizing the parts must remain fully plunged as recommended by the sanitizer manufacturer.
- **A**fter respecting the correct sanitizing period, rinse well all the components with clean water and dry them up with a clean cloth.
- **O**nce performed all these cleaning and sanitizing procedures, it's possible to reassemble all the components.
- **W**hen fitting, position the seal (G) as shown in fig 5.
- **I**n order to facilitate fitting operations, spread Vaseline or another suitable lubricant over the seat of the container (A) where it comes into contact with the seal (G) (fig. 5).
- **P**ull the lever (F) outwards, pushing the tank downwards so that it fits into its seat (fig 5).
- **R**e-insert the tap spreading Vaseline on the O-rings to facilitate sliding the tap in its seat until completely inserted.
- **R**e-assemble the mixer back on the shaft and check for their correct coupling.
- **C**heck for the G gasket position in order to avoid any possible interference with the mixer rotation.
- **R**eassemble the drip tray.

!Warning!

If the tap does not perfectly slide into position, the sealing hold will be endangered.

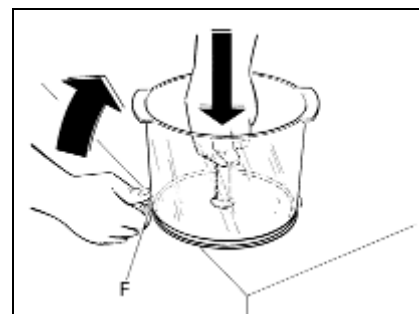

Fig. 4

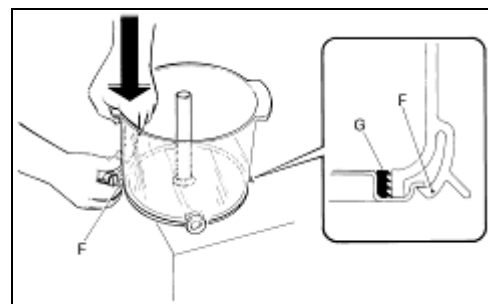

Fig. 5

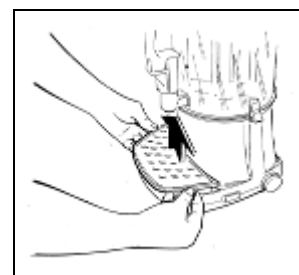

Fig. 6

Sanitizing

Whenever the machine has remained unused for some days after been cleaned and sanitized as described in the chapter 10, the sanitizing procedures described below must be performed just prior to start-up the machine.

- Remove the main cover and the secondary one.
- Pour sanitizing solution into the bowl carefully following the manufacturer prescriptions.
- After restoring the main cover, switch on the machine and let the auger rotating (all control board LED switched off) leaving the sanitizing solution for the time specified by its producer.

IMPORTANT

Never let the sanitizer inside the bowl longer than the producer prescriptions .

- Drain the solution by opening the plunger to allow the bowl to empty. Open and close the plunger at least 10 times during draining to sanitize the product way out area also.
- Thoroughly rinse repeating these operations with clean water instead of sanitizer solution.
- Now the machine is ready to be used.
- Anytime that you replace the grasp container on the plate, make sure that the probe (K) touches the bottom of the grasp container perfectly (see fig. 7).

Seals control and replacement

Bowl gasket

Replace it every 12 months according to the conditions of use and level of maintenance.

Dispense valve O-Ring

The dispense valve O-rings should be replaced as necessary when wear is evident.

Lubricate them each time they are replaced or the dispense valve is removed for cleaning.

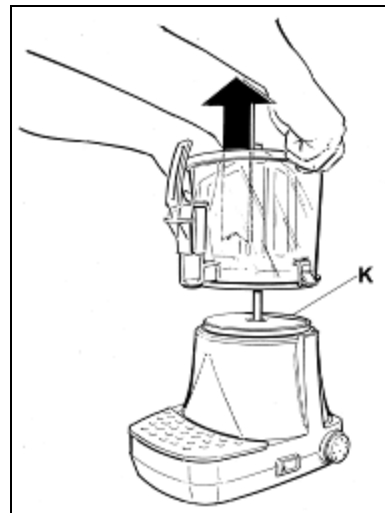

Fig. 7

2. TECHNICAL SPECIFICATIONS

Technical and electrical specifications

All the machine's technical and electrical specifications are stated on the identification plate, positioned in the internal part of the equipment; a sample is shown here below.

The plate specifies:

- Model: XX
- n°: XX
- Electrical specifications: Volt/ Hz
- Max. absorption (Watt)
- Max. current (Amp)

Dimensions and weight:

	LOLA3		LOLA6	
Height cm/in	43.5	17.1	46.5	18.3
Width cm/in	23.5	9.3	27	10.7
Depth cm/in	28	11	32	12.6
Weight kg/lb	5.2	11.5	6.2	13.7

In the event of breakdown:

In most cases, any technical problem can be settled with slight interventions (please see the troubleshooting guide at the end of this manual); we therefore recommend you to carefully read this handbook before contacting the manufacturer or service centre.

Disposal



Caution

All the parts of the packaging must be kept beyond the range of children, as they might represent a potential safety/health risk.

Important

In respect of the environment, please dispose the packaging as illustrated.



This symbol:  means that the machine cannot be disposed as common waste. It must be handled in compliance with the provisions of European directive 2003/108/EC (Waste Electrical and Electronic Devices - WEEE) and the resulting national legislation, in order to prevent any potential damage to the environment and to create health risks.

In order to correctly dispose of the device, please contact the distributor from which you purchased it or our after-sales service.

Equipment kit:

In the packaging of this equipment you will find also:

- operator's manual,
- 1 tube of Vaseline grease lubricant to be used for machine maintenance;
- EC declaration of conformity.

3. POSITIONING

FOR MAINTENANCE WORKER ONLY

- a) Remove the packing and preserve it in order to reuse for winter storage.



Caution

All the parts of the packaging must be kept beyond the range of children, as they might represent a potential safety/health risk.

- b) Make sure the machine is in perfect condition.

- c) Check that the power mains voltage meets the specifications on the equipment identification plate and that the output available meets the device's power requirements.

Fit the plug into an earthed socket, removing all multiple adaptors.

FOR FURTHER PRECAUTIONS, READ THE SECTION "CONNECTION TO THE ELECTRICITY MAINS" CAREFULLY.

d) The installation must be carried out in accordance with the manufacturer's instructions. Failure to comply with the positioning and installation instructions may impair the machine's operation.

Important

You are legally required to provide a suitable grounding system for the equipment. Before carrying out any cleaning and/or special maintenance on the device, make sure it is disconnected from the mains by unplugging it. In the event of a breakdown or malfunctioning, switch off the device and remove the plug.

4. CONNECTION TO THE POWER SUPPLY MAINS

FOR SERVICEMAN ONLY

Before fitting the plug in the power supply socket, for your own safety, as already mentioned in the previous paragraph, please read the following precautions.

- The machine's electrical safety is only guaranteed when it is connected to a suitable earth system, structured as provided by the national safety current regulations (fig.8). Therefore, the manufacturer cannot be held responsible for any damage due to failure of the grounding system of the machine.

- Always verify electrical specifications on the data plate of each machine. Data plate specifications always replace the information of this manual.

- Never use extensions or multiple adaptors.

- Check the power lead along its entire length to make sure it is not crushed in any way.

- To unplug the device, first disconnect the power supply with the switch, then grip the plug and gently pull it out.

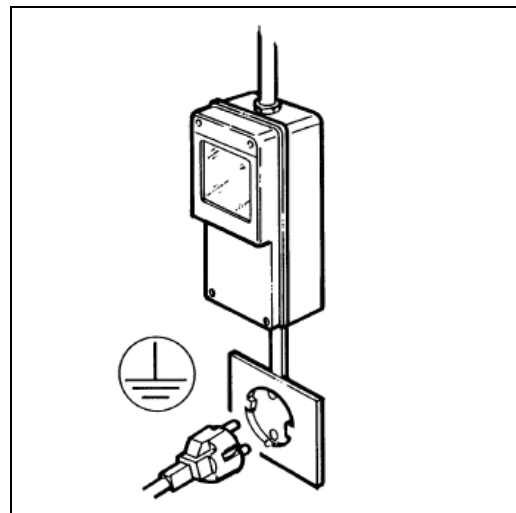

Fig. 8

- If required by local regulations, it is possible to have the appliance permanently connected to electrical power supply, ref. National Electrical Code (NEC) and NFPA 70. If this is the case, it is necessary to remove the right side panel, disconnect the power cable from the machine wiring, remove it from the machine and replace it with the permanent cable by respecting the local codes.

5. START-UP PROCEDURES AND OPERATING INSTRUCTIONS

!!IMPORTANT!
BEFORE STARTING THE MACHINE, CARRY OUT THE CLEANING AND SANITISING PROCEDURES DESCRIBED IN CHAPTER 7.

- Dilute and mix the product in a separate container according to the manufacturer's instructions (see fig.9).

NOTE: "mix" is the result of the blending between water or milk with the powder to make hot chocolate and similar products.

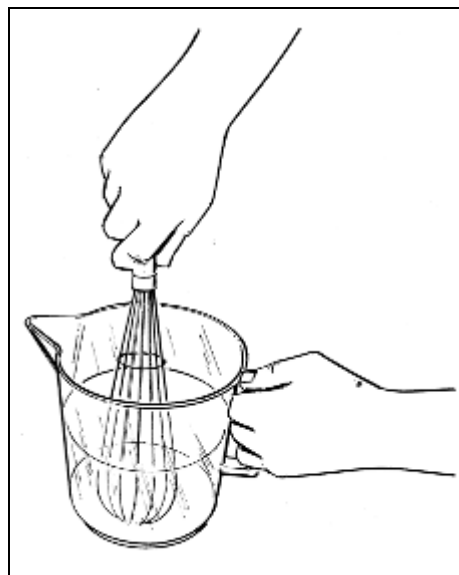

Fig. 9

- Plug the machine to the electric supply (fig.10).

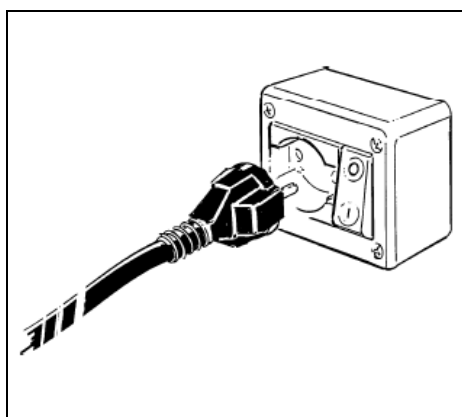

Fig. 10

- Lift up the lid and pour the product into container (A) and turn the machine on at switch (B). Put the thermostat (C) at the maximum temperature (see fig.11). Wait for the product to reach the right temperature to be dispensed.



Attention

Before pouring product into the container A, make sure the mixing element E has been correctly assembled on the central shaft; failure to do so could damage the machine.



Attention

Always pour a quantity of product able to completely cover the base of the bowl and always pour fresh product when the base is also only partially visible in order to completely cover it back; failure to do so could damage the machine.

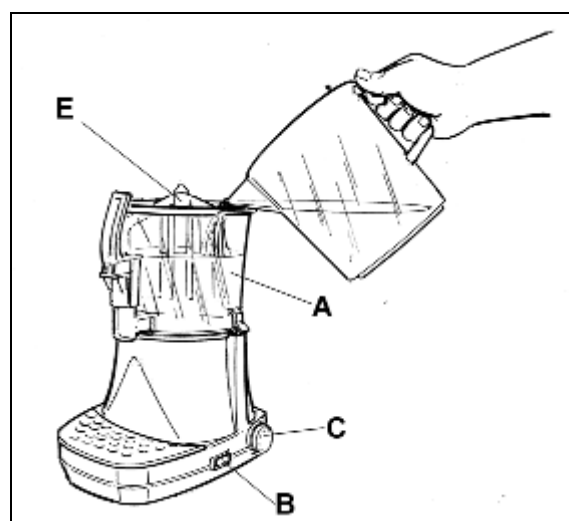

Fig. 11

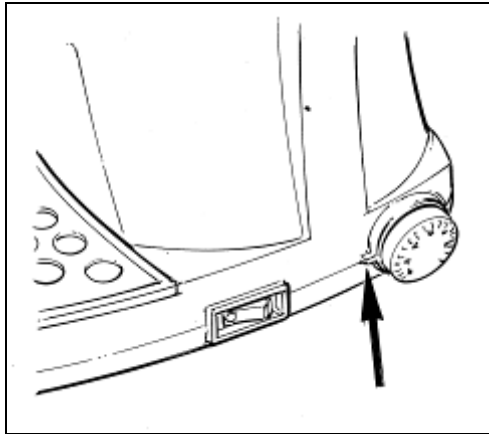

Fig. 12

- In order to regulate the desired temperature, rotate the thermostat knob until this temperature will match the plastic pin indicated by the arrow in figure 12.

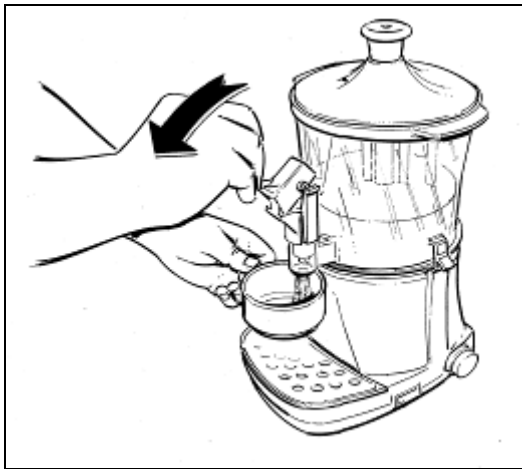

Fig. 13

- Once the desired product temperature is reached, in order to dispense product, place a cup under the tap and lower the lever as shown in figure 13.

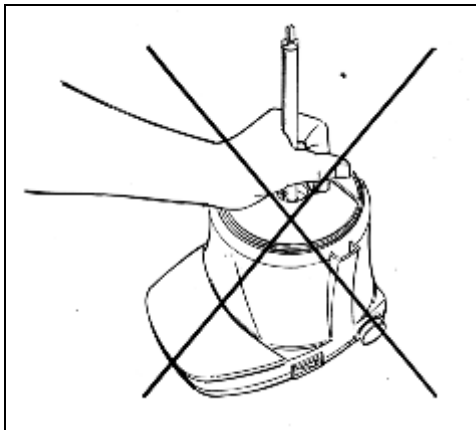

Fig. 14

Never touch the plate with hands when the container is not positioned in its place (see fig. 14).

**⚠ Attention ⚠
BURNS RISK**



Summer storage

To protect the unit during seasonal shutdown, it's important to properly store the machine using the following procedures:

- Disconnect all power to the machine.
- Disassemble, wash and sanitize all parts that come into contact with the mix as described in chapter 1.
- Clean also all the exterior panels.
- Reassemble all these parts.
- Cover the machine with the original package to protect it from dust or other contaminating elements.
- Place the machine in dry location.

Product storage

Since the safety of the product used with this unit depends upon the temperature and the duration of storage, it is necessary to refer directly to the food product producer instruction and specifications in order to correctly manage it and in order to avoid any possible safety issue.

6. DISCLAIMER

The manufacturer declines all responsibility for any damage that directly or indirectly might be brought on to people, things, animals, as a consequence of failure to comply with all instructions given in this manual with the warnings concerning installation procedures, use and maintenance of the machine.

The manufacturer cannot be held responsible for possible mistakes due to printing, copying or translating errors contained in this manual. In addition, the manufacturer reserves the right to modify what deemed necessary or useful for the machine, as well as for the benefit of the user, yet at the same time maintaining the essential operative and safety characteristics of said machine.

7. WIRING DIAGRAM

SCHEMATIC WIRING DIAGRAM FOR LOLA

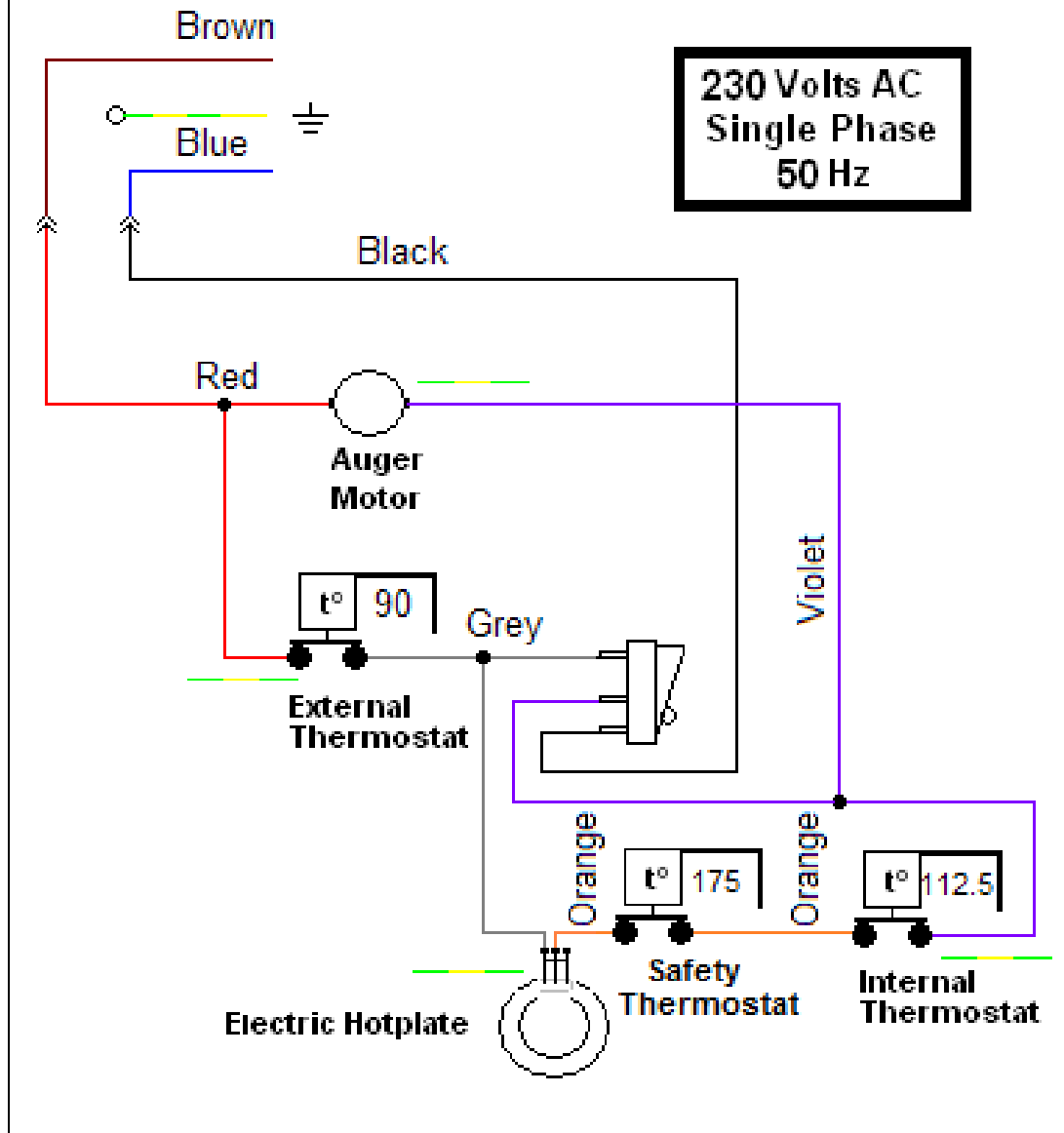

ASSISTENZA TECNICA ITALIA

Mail:

infoservicek@electroluxprofessional.com

Tel. +39 059 782884

INTERNATIONAL CUSTOMER CARE

Mail:

SPM.aftersales@electroluxprofessional.com

Phone: +39 059 781761

US CUSTOMER CARE

Grindmaster-Cecilware

4003 Collins Lane, Louisville, KY 40245 USA

Phone: 502.425.4776 Toll Free: 800.695.4500

Fax: 502.425.4664

Web: www.grindmaster.com/service

ELECTROLUX PROFESSIONAL

Mail:

epr.techhelp@electroluxprofessional.com



S.P.M. Drink Systems S.p.A.
Via Panaro 2/b
41057 Spilamberto (MO)